

SMD SPX0 5.0x3.2mm 1.8 - 5.0 VDC MHz

SERIES "SX0"

FEATURES

- + High reliability for low cost
- + Low-priced SMD-clock-oscillator
- + Frequency stability from ± 20 to ± 100 ppm available
- + Supply voltage of 1.8, 2.5, 2.8, 3.3 and 5.0 VDC deliverable
- + New standard for small low cost oscillators
- + Extended temperature range -40°C to $+125^{\circ}\text{C}$

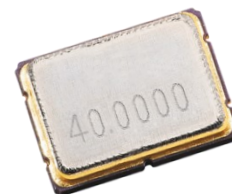

PB FREE / ROHS-2 2011/65/EU COMPLIANT

GENERAL DATA

PARAMETERS		PRODUCT FEATURES AND CONDITIONS		
SMD-OSCILLATOR SERIES		SX0-05032		
PACKAGE		Ceramic package 5.0 x 3.2 x 1.2 mm ³		
FREQUENCY RANGE		1.0~ 160.0 MHz		
FREQUENCY STABILITY		-10/+60°C ~ -10/+70°C	$\pm 20 \sim \pm 100$ ppm	
		-20/+70°C ~ -40/+85°C	$\pm 25 \sim \pm 100$ ppm	
		-40/+85°C ~ -40/+105°C	$\pm 50 \sim \pm 100$ ppm	
		-40/+125°C	± 100 ppm	
		The frequency stability contains the frequency tolerance at 25°C, the temperature stability, supply voltage change and load change. The aging is ± 3 ppm max. per year.		
OPERATING TEMPERATURE RANGE		$-10/+60^{\circ}\text{C} \sim -40/+125^{\circ}\text{C}$		
STORAGE TEMPERATURE RANGE		$-55/+125^{\circ}\text{C}$		
INPUT	CURRENT	FREQUENCY	+1.8 VDC $\pm 10\%$	
		1.0~4.0 MHz	10 mA max.	
		4.0~45.0 MHz	30 mA max.	
		45.0~112.0 MHz	45 mA max.	
		112.0~160.0 MHz	90 mA max.	
		FREQUENCY	+2.5 VDC $\pm 10\%$	+2.8 VDC $\pm 10\%$
		1.0~4.0 MHz	10 mA max.	10 mA max.
		4.0~45.0 MHz	30 mA max.	30 mA max.
		45.0~112.0 MHz	45 mA max.	45 mA max.
		112.0~160.0 MHz	90 mA max.	90 mA max.
		FREQUENCY	+3.3 VDC $\pm 10\%$	+5.0 VDC $\pm 10\%$
		1.0~4.0 MHz	10 mA max.	10 mA max.
		4.0~45.0 MHz	30 mA max.	30 mA max.
		45.0~112.0 MHz	45 mA max.	45 mA max.
112.0~160.0 MHz	90 mA max.	90 mA max.		

GENERAL DATA (CONTINUED)

PARAMETERS		PRODUCT FEATURES AND CONDITIONS			
OUTPUT	SYMMETRY	STANDARD	40/60%		
		OPTION	45/55%		
	RISE AND FALL TIME		5 ns typical /10ns max.		
	"0" LEVEL	TTL	0.4 V max.		
	"1" LEVEL		+2.4 V min.		
	"0" LEVEL	CMOS	10% VDD min.		
	"1" LEVEL		90% VDD max.		
LOAD		+1.8 VDC ~ +2.8 VDC ±10%	+3.3 VDC ±10%	+5.0 VDC ±10%	
	TTL	1 ~ 5 TTL	1 ~ 10 TTL	1 ~ 10 TTL	
	CMOS	15 pF max.	15 ~ 30pF (15pF typical)	15 ~ 50pF	
PIN1	STANDARD	WITHOUT ENABLE / DISABLE FUNCTION			
	OPTION	WITH ENABLE / DISABLE FUNCTION			
ENABLE / DISABLE FUNCTION		PIN #1 (E/D CONTROL)		PIN #3 (OUPUT)	
		OPEN		ACTIVE	
		HIGH "1" (VIH >70%VDC)		ACTIVE	
		LOW "0" (VIL <30%VDC)		HIGH IMPEDANCE	
		OUTPUT DISABLE TIME		150 ns max.	
		OUTPUT ENABLE TIME		10 ms max.	
DELIVERY FORM		Tape and Reel / 1.000 pcs. per reel, other quantities are available on request			
OTHER PARAMETERS ARE AVAILABLE ON REQUEST / CREATE HERE YOUR SPECIFICATION					

OUTLINE DRAWING

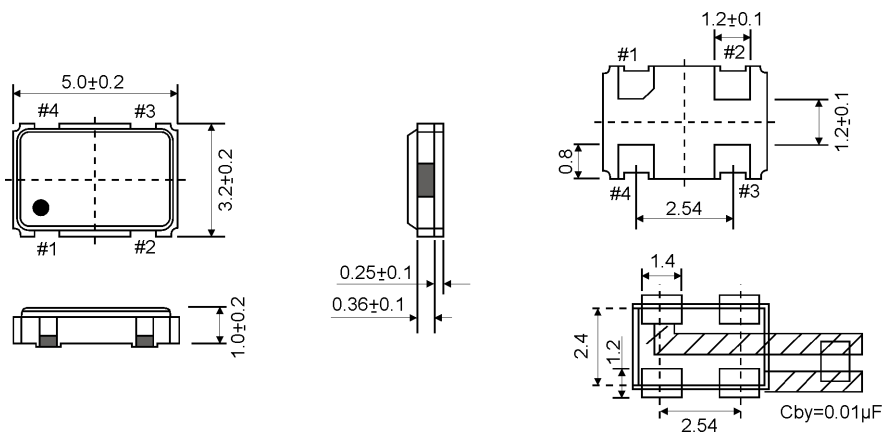

PIN	FUNCTION
#1	N.C. OR ENABLE / DISABLE
#2	GROUND
#3	OUTPUT
#4	VDD

Unit:mm

REEL SPECIFICATION

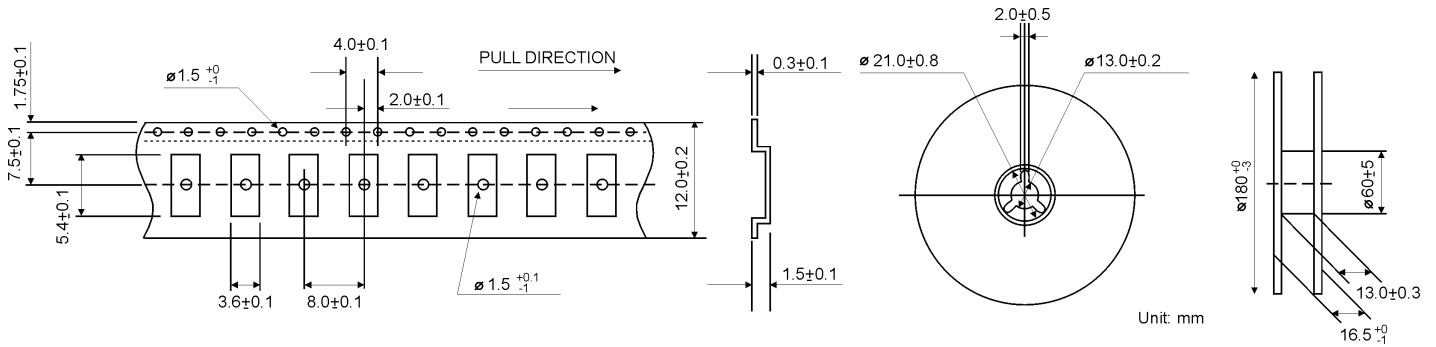

TEST CIRCUIT FOR CMOS

TEST CIRCUIT FOR TTL

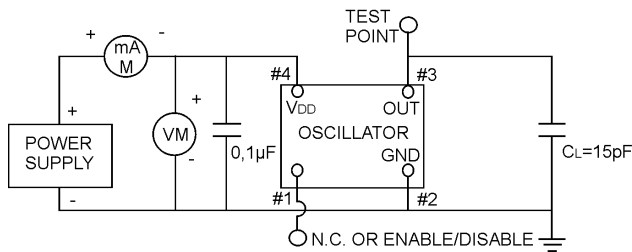

NOTE: CL includes probe and fixture capacitance

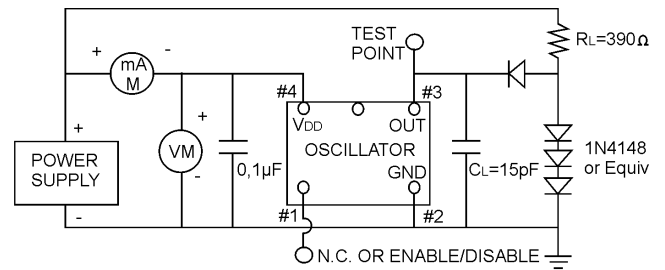

NOTE: CL includes probe and fixture capacitance

OUTPUT WAVE FORM CMOS

OUTPUT WAVE FORM TTL LOAD

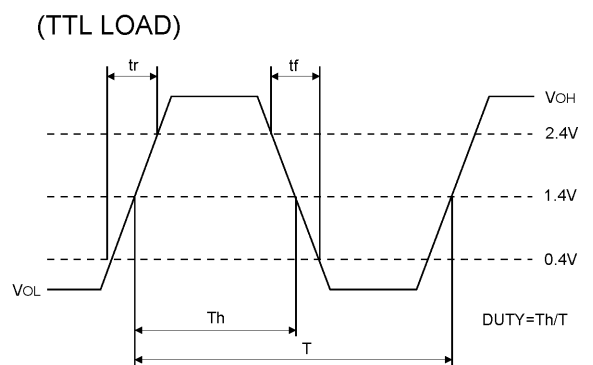
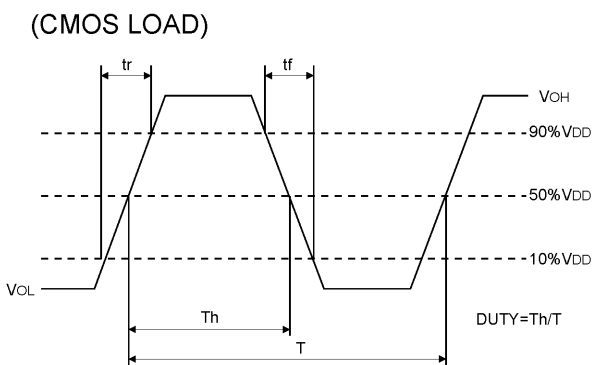



REFLOW SOLDER PROFILE

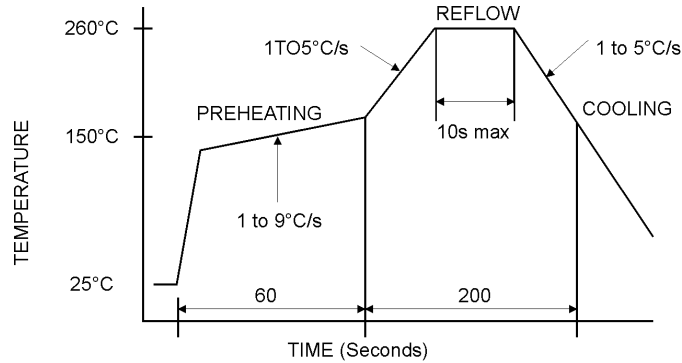

Oscillators can be soldered according to the norm JEDEC J-STD-020C.

ORDERING INFORMATION

SERIES & VOLTAGE
 SX018 = 1.8V
 SX025 = 2.5V
 SX028 = 2.8V
 SX03 = 3.3V
 SX0 = 5.0V

SYMMETRY
 "-" = 40/60%
 "S" = 45/55%

FREQUENCY STABILITY
 "20" = ±20PPM
 "25" = ±25ppm
 "50" = ±50PPM
 "-" = ±100PPM

FREQUENCY RANGE
 1.0 - 160.0 MHz

SX018-05032-S-E-20-M-27.000MHz-T

PACKAGE SIZE
 "05032" = 5.0X3.2MM

PIN1
 "-" = NOT CONNECTED
 "E" = ENABLED/DISABLED

TEMPERATURE RANGE
 "-" = 0/+70°C
 "N" = -10/+60°C
 "M" = -20°/+70°C
 "W" = -40°/+85°C
 "Y" = -40°/+105°C
 "Z" = -40°/+125°C

DELIVERY FORM
 "T" = TAPE AND REEL

EXAMPLE: SX018-05032-S-E-20-M-27.000MHz-T
 PLEASE INDICATE YOUR REQUIRED PARAMETERS



PREMIUM QUALITY BY PETERMANN-TECHNIK



OUR COMPANY IS CERTIFIED ACCORDING TO ISO 9001:2015 IN OCTOBER 2016 BY THE DMSZ CERTIFIKATION GMBH.

THIS IS FOR YOU TO ENSURE THAT THE PRINCIPLES OF QUALITY MANAGEMENT ARE FULLY IMPLEMENTED IN OUR QUALITY MANAGEMENT SYSTEM AND QUALITY CONTROL METHODS ALSO DOMINATE OUR QUALITY STANDARDS.